



## Concept

### L'arma da Cross Country definitiva:

Fourstroke 01 è nata per limare secondi sui percorsi più selettivi, sia in salita che in discesa. Progettata come un sistema unico, Fourstroke 01 è la nostra bici da gara più veloce ed intuitiva di sempre.

### Il primo reggisella telescopico integrato per il Cross Country

RAD (Race Application Dropper) è il primo reggisella telescopico integrato al mondo. Una soluzione ingegneristica unica e dal peso minimo, ispirata dallo stile di guida progressivo dei nostri atleti e dai tracciati più tecnici del circuito World Cup.

### Big Wheel Concept Race, una nuova era

La geometria BWC Race (Big Wheel Concept) asseconda gli stili di guida più aggressivi tramite l'angolo di sterzo aperto, l'avantreno allungato, i foderi posteriori compatti ed un attacco manubrio dal design innovativo.

### Costruita per l'efficienza

Non accettate compromessi con un telaio superleggero progettato per rigidità ed accelerazione da primato. La schema di sospensione APS (Advanced Pivot System) permette perfetta efficienza durante la pedalata oltre ad eccezionale trazione e controllo su ogni percorso di gara.

## Details

### Kit Cadre

Telaio	Fourstroke 01 - Advanced Pivot System (escursione 100 mm), movimento centrale PF92, perno passante 12 x 148 mm Boost
Reggisella	RAD Race Application Dropper - Escursione 80 mm
Tecnologia del telaio	Reggisella RAD, Geometria Big Wheel Concept Race
Taglia	4 taglie: S / M / L / XL
Peso telaio	2180 g*
Peso reggisella	345 g**

### Integrazione

Telaio	Reggisella integrato Passaggio cavi interno Protezioni telaio integrate Fermi fine corsa forcella integrati
--------	--

### Dettagli tecnici

Telaio	Perno passante 12 x 148 mm Boost, Tubo sterzo 1,5"
Forcella	Canotto conico da 1-1/8» a 1-1/2» Offset 44 mm Escursione 100 mm
Reggisella	Telescopico integrato RAD Race Application Dropper - escursione 80 mm, sezione ellittica (34,1 x 25,6 mm)
Movimento centrale	PF92
Freni	Postmount 160 / 160***
Trasmissione	Specifica 1x
Linea catena Boost	Forcellino cambio sostituibile standard o direct mount
Pneumatici	Larghezza massima 58 mm****
Varie	Corona massima 38 denti (pedivelle 1X boost) Ammortizzatore metrico 185 mm x 50 mm, montaggio trunnion, viteria 20 x 8 mm

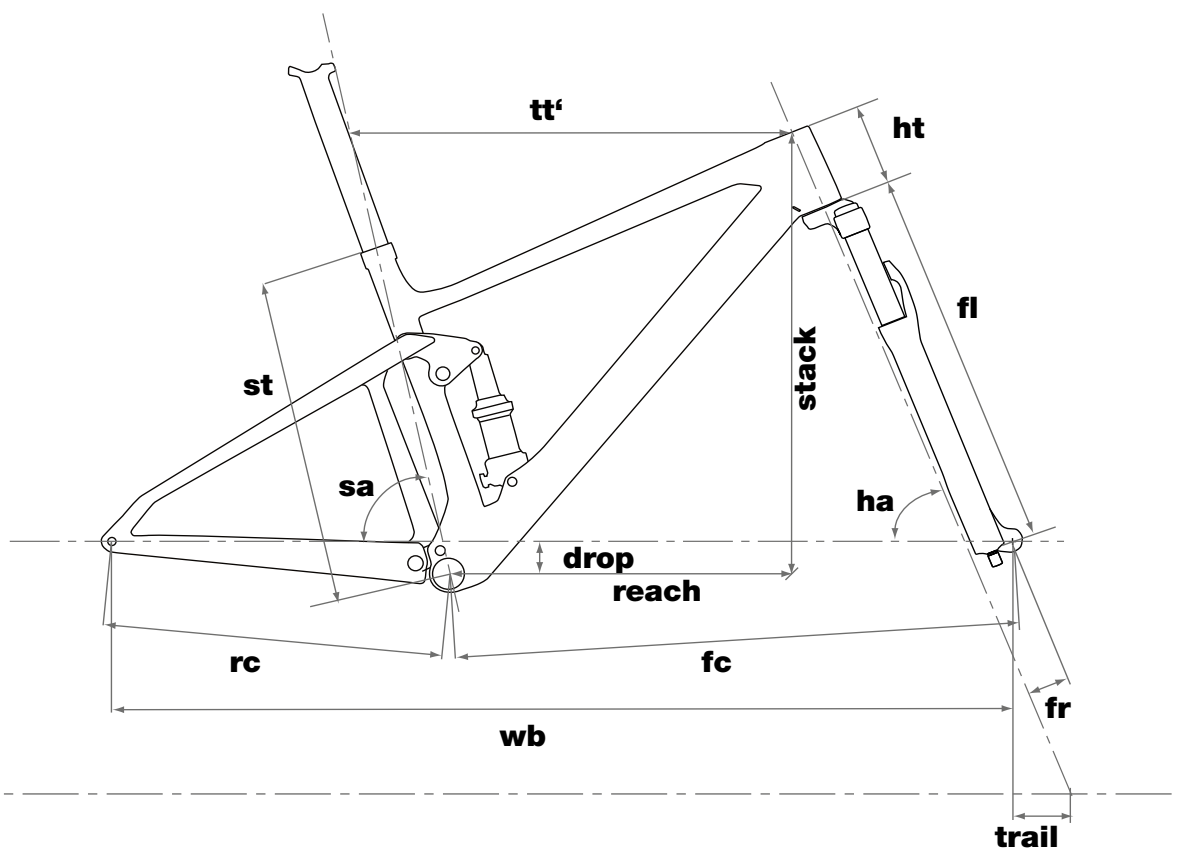

Geometry

size	S	M	L	XL
rider height	<172	172-182	180-188	>188
stack mm	580	590	600	615
reach mm	423	445	465	485
seat tube st mm	420	440	480	510
top tube tt' mm	582	607	630	654
head tube ht mm	96	107	117	134
seat angle sa °	75.6	75.6	75.6	75.6
head angle ha °	67.5	67.5	67.5	67.5
rear center rc mm	429	429	429	429
front center fc mm	700	726	750	777
wheelbase wb mm	1129	1155	1180	1206
bb drop mm	44	44	44	44
fork length fl mm	506	506	506	506
fork rake fr mm	44	44	44	44
trail mm	106.5	106.5	106.5	106.5
crank length mm	170	175	175	175
stem length mm	50	60	60	70
stem angle °	-5	-5	-5	-5
bar width mm	720	720	720	720
bar rise mm	0	0	0	0
bar sweep °	9	9	9	9
post offset mm	0	0	0	0
standover height mm	738	747	759	768
rear travel mm	105	105	105	105



**FOURSTROKE 01 ONE**

	Fourstroke 01 - Advanced Pivot System, PF92 Bottom Bracket, 12 x 148mm Thru-axle
	01 Premium Carbon (F&R)
	S / M / L / XL
	Fox Float 32 SC, Factory, FIT4, Kashima, Remote (100mm), 15x110mm thru-axle
	Fox Float DPS, Factory, Evol, Kashima, Remote (100mm)
	1x12
	SRAM XX1 Eagle 34T
	SRAM XG 1295 10-50T
	SRAM X01 Eagle Black
	SRAM XX1 Eagle
	SRAM XX1 Eagle
	SRAM Level Ultimate (160/160) *
	BMC MFB 01 Carbon, 750mm
	BMC MSM 01
	BMC Integrated Dropper Post (80mm travel)
	Fizik Antares R5 K.i.ium
	DT Swiss XRC 1200
	DT Swiss XRC 1200 Carbon 25**
	Vittoria Barzo TR, 29x2.25
	Ultramarine

Note \* M size spec - rotor size adjusted for some sizes  
 \*\* Tubeless rim strip installed, valve included

Specifications are subject to change without notice



**FOURSTROKE 01 TWO**





















	Fourstroke 01 - Advanced Pivot System, PF92 Bottom Bracket, 12 x 148mm Thru-axle
	01 Premium Carbon (F&R)
	S / M / L / XL
	Fox Float 32 SC, Performance, Grip, Remote (100mm), 15x110mm thru-axle
	Fox Float DPS, Performance Elite, Evol, Remote (100mm)
	1x11
	Shimano XTR
	Shimano XTR
	Shimano XTR
	Shimano XTR, Shadow Plus
	Shimano XTR
	Shimano XTR (160/160mm) *
	BMC MFB 01 Carbon, 750mm
	BMC MSM 01
	BMC Integrated Dropper Post (80mm travel)
	Fizik Antares R7
	DT Swiss XR 1501 Spline ONE
	DT Swiss XR 1501 Spline ONE 25 **
	Vittoria Barzo TR, 29x2.25
	Stealth

Note \* M size spec - rotor size adjusted for some sizes  
 \*\* Tubeless rim strip installed, valve included

Specifications are subject to change without notice



**FOURSTROKE 01 THREE**

	Fourstroke 01 - Advanced Pivot System, PF92 Bottom Bracket, 12 x 148mm Thru-axle
	01 Premium Carbon (F&R)
	S / M / L / XL
	Fox Float 32 SC, Performance, Grip, Remote (100mm), 15x110mm thru-axle
	Fox Float DPS, Performance Elite, Evol, Remote (100mm)
	1x12
	SRAM Gx Eagle, 32T
	SRAM Gx Eagle, 10-50T
	SRAM Gx Eagle
	SRAM Gx Eagle
	SRAM Gx Eagle
	Shimano SLX (160/160mm) *
	BMC MFB 02 , 750mm
	BMC MSM 01
	80mm Drop
	Fizik Antares R7
	DT Swiss X1700 Spline
	DT Swiss X1700 Spline 25 **
	Vittoria Barzo TR, 29x2.,25
	Race grey

\* M size spec - rotor size adjusted for some sizes

Note







\*\* Tubeless rim strip installed, valve included

Specifications are subject to change without notice





**FOURSTROKE 01** Frameset

	Fourstroke 01 - Advanced Pivot System, PF92 Bottom Bracket, 12 x 148mm Thru-axle
	01 Premium Carbon (F&R)
	S / M / L / XL
	Fox Float DPS, Factory, Evol, Kashima, Remote (100mm)
	BMC MSM 01
	BMC Integrated Dropper Post (80mm travel)
	Stealth

Specifications are subject to change without notice